

## Central Texas Metal Roofing Supply Co., Inc

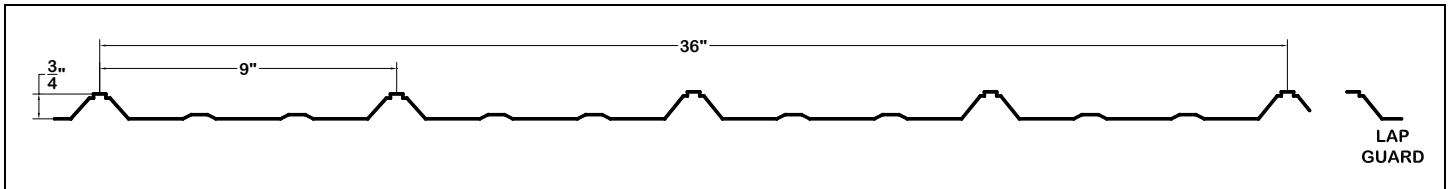

GAUGE	PANEL	FINISH	NET COVERAGE	SHEET WIDTH	WEIGHT PER SQ.		
26	FRONTIER RIB	GALVALUME®	36"	38 1/4"	95.00		
26	LAP GUARD	GALVALUME®	36"	40 1/4"	95.00		
26	FRONTIER RIB	SMP	36"	38 1/4"	95.00		
26	LAP GUARD	SMP	36"	40 1/4"	95.00		
24	FRONTIER RIB	GALVALUME®	36"	38 1/4"	121.00		
24	LAP GUARD	GALVALUME®	36"	40 1/4"	121.00		
24	LAP GUARD	KYNAR500®	36"	40 1/4"	121.00		
24	LAP GUARD	PREMIUM KYNAR500®	36"	40 1/4"	121.00		

### PANEL PRICING:

1. Price per Square is based on 38 1/4" sheet width.
2. Add \$ 2.00 per each panel less than 3'-0".
3. For all Kynar500® orders less than 10 SQ please add \$300.00
4. Add \$ 40.00 set up charge for reverse run panels. (Color upside down).
5. Panels longer than 45' will have a 10% surcharge.

### PACKAGING PRICING:

1. Maximum weight of one bundle is 3,000 pounds or 75 panels.
2. Standard packaging - band with guard, top waster sheet  
\$10.00/bundle      \$20.00 over 16'
3. Block and band, top waster sheet  
\$15.00/bundle      \$25.00 over 16'
4. Block and band, top and bottom waster sheet  
\$25.00/bundle      \$40.00 over 16'
5. LTL Crating - block and band, top and bottom waster sheet  
\$5.00/linear foot, minimum charge \$40.00

Orders less than 5 panels will require block and band, top waster sheet

**Galvalume® and Acrylic Coated Galvalume® are unfinished products.**  
**Shade variations, color difference and a rate of weathering in unfinished product such as Galvalume® and Acrylic Coated Galvalume® should be anticipated and are not a cause for rejection.**  
**Use a pre-painted finish if uniform weathering and appearance is crucial.**

**Austin – Headquarters / Sales Office**  
 830 Sagebrush Dr Austin, Texas 78758  
 (512) 452-1515 (800) 428-7412  
 Fax (512) 833-7499

www.ctmrs.com  
 email: info@ctmrs.com

**Seguin – Plant / Sales Office**  
 720 West IH 10 Seguin, Texas 78155  
 (830) 379-3600 (877) 622-8677  
 Fax (830) 379-8753

Central Texas Metal Roofing Supply Co., Inc

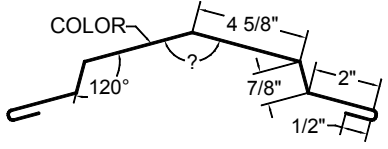
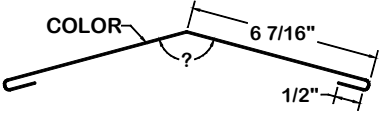
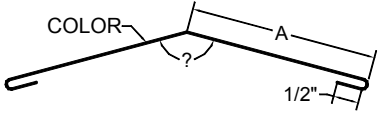
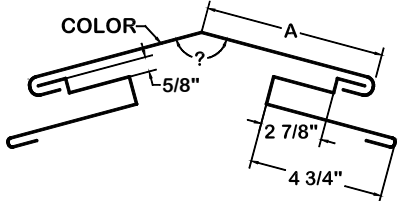
ITEM	DESCRIPTION						
	PART NUMBER	LENGTH	GIRTH	WEIGHT			
<b>UNIVERSAL RIDGE CAP</b> 	T100/10	10'-0"	16"	12.67			
	T100/20	20'-2"	16"	25.54			
SPECIFY ANGLE OR ROOF SLOPE							
<b>HIP / RIDGE CAP</b> 	T101/10	10'-0"	13 7/8"	10.89			
	T101/20	20'-2"	13 7/8"	21.95			
SPECIFY ANGLE OR ROOF SLOPE							
<b>HIP / RIDGE CAP - EXTENDED</b> 	T102/10	10'-0"	16"	12.67			
	T102/20	20'-2"	16"	25.54			
	T103/10	10'-0"	24"	19.00			
	T103/20	20'-2"	24"	38.32			
T102 - A = 7 1/2" T103 - A = 11 1/2" SPECIFY ANGLE OR ROOF SLOPE							
<b>VENTED RIDGE CAP</b> 	T110/10	10'-0"	38 3/4"	30.68			
	VENTED AREA = 4.62SQ IN/LF DIM "A" DEPENDS ON THE ROOF SLOPE. SLOPE                      DIM "A" 1/4 /12 to 6 /12            6 7/16" 6 1/8 /12 to 9 /12        7 1/2" 9 1/8 /12 to 12/12        8 1/2"						
Kynar 500 ® Flashing – 24Ga Typ. Galvalume® and SMP Flashing – 26Ga Typ. Galvalume® = Acrylic Coated Galvalume Galvalume is a trademark of BIEC , Inc.							



**Austin – Headquarters / Sales Office**  
 830 Sagebrush Dr Austin, Texas 78758  
 (512) 452-1515 (800) 428-7412  
 Fax (512) 833-7499

www.ctmrs.com  
 email: info@ctmrs.com

**Seguin – Plant / Sales Office**  
 720 West IH 10 Seguin, Texas 78155  
 (830) 379-3600 (877) 622-8677  
 Fax (830) 379-8753

# Frontier Rib

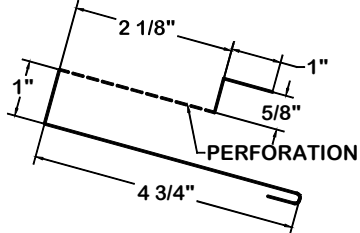
Central Texas Metal Roofing Supply Co., Inc

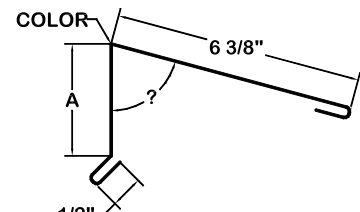
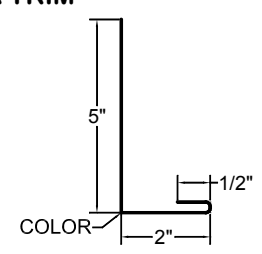
ITEM	DESCRIPTION				PRICE PER EACH		
	PART NUMBER	LENGTH	GIRTH	WEIGHT			
<b>VENTED SKIRT</b> 	T400/10	10'-0"	10"	8.21			
	<b>VENTED AREA = 2.31 SQ IN/LF</b>						
<b>VENTED RIDGE END CAP</b> 	T151/10	18"	N/A	.15			
	<b>PRE NOTCHED FOR ADJUSTMENT TO ROOF SLOPE</b>						
<b>PEAK FLASHING / HIGH SIDE EAVE</b>  <p>SPECIFY ANGLE OR ROOF SLOPE</p>	T152FR/10	10'-0"	10 1/8"	8.41			
	T152FR/20	20'-2"	10 1/8"	16.96			
	T153FR/10	10'-0"	12 7/8"	10.59			
	T153FR/20	20'-2"	12 7/8"	21.35			
	<b>T152FR- A = 2 1/4"</b> <b>T153FR-A = 5"</b>						
	<b>COLOR</b>						
<b>FASCIA TRIM</b> 	T154/10	10'-0"	7 1/2"	5.94			
	T154/20	20'-2"	7 1/2"	11.97			
<b>Kynar 500 ® Flashing – 24Ga Typ.</b> <b>Galvalume® and SMP Flashing – 26Ga Typ.</b> <b>Galvalume® = Acrylic Coated Galvalume</b> <b>Galvalume is a trademark of BIEC , Inc.</b>							

**Austin – Headquarters / Sales Office**  
 830 Sagebrush Dr Austin, Texas 78758  
 (512) 452-1515 (800) 428-7412  
 Fax (512) 833-7499

[www.ctmrs.com](http://www.ctmrs.com)  
 email: [info@ctmrs.com](mailto:info@ctmrs.com)

**Seguin – Plant / Sales Office**  
 720 West IH 10 Seguin, Texas 78155  
 (830) 379-3600 (877) 622-8677  
 Fax (830) 379-8753

# CTMRS

# Frontier Rib

Central Texas Metal Roofing Supply Co., Inc

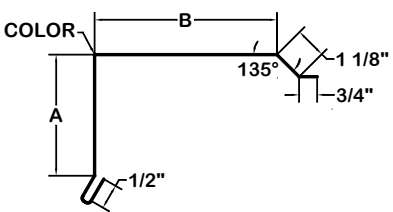
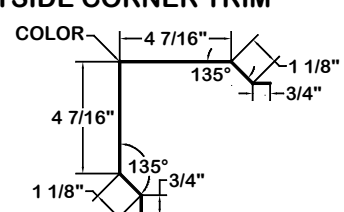
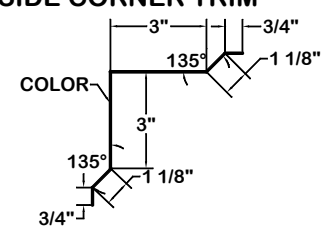
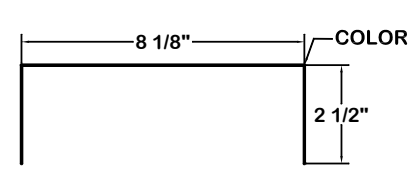
ITEM	DESCRIPTION				PRICE PER EACH		
	PART NUMBER	LENGTH	GIRTH	WEIGHT			
<b>RAKE TRIM</b> 	T155FR/10	10'-0"	10 7/8"	8.21			
	T155FR/20	20'-2"	10 7/8"	16.56			
	T156FR/10	10'-0"	12"	9.90			
	T156FR/20	20'-2"	12"	19.96			
	T155UP - A = 2 3/4"	B = 5 1/4"					
	T156UP - A = 5"	B = 4 1/8"					
<b>OUTSIDE CORNER TRIM</b> 	T157FR/10	10'-0"	12 5/8"	9.99			
	T157FR/20	20'-2"	12 5/8"	20.16			
<b>INSIDE CORNER TRIM</b> 	T158FR/10	10'-0"	9 3/4"	7.72			
	T158FR/20	20'-2"	9 3/4"	15.57			
<b>JAMB / HEAD CAP</b> 	T159/10	10'-0"	13 1/8"	10.39			
	T159/20	20'-2"	13 1/8"	20.95			

Kynar 500 ® Flashing – 24Ga Typ.  
 Galvalume® and SMP Flashing – 26Ga Typ.  
 Galvalume® = Acrylic Coated Galvalume  
 Galvalume is a trademark of BIEC , Inc.

**Austin – Headquarters / Sales Office**  
 830 Sagebrush Dr Austin, Texas 78758  
 (512) 452-1515 (800) 428-7412  
 Fax (512) 833-7499

www.ctmrs.com  
 email: info@ctmrs.com

**Seguin – Plant / Sales Office**  
 720 West IH 10 Seguin, Texas 78155  
 (830) 379-3600 (877) 622-8677  
 Fax (830) 379-8753

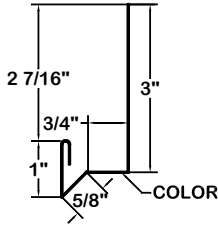
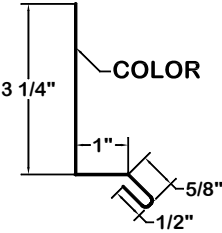
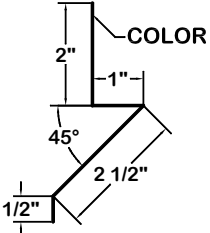
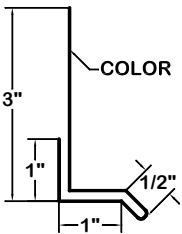

ITEM	DESCRIPTION				PRICE PER EACH		
	PART NUMBER	LENGTH	GIRTH	WEIGHT			
<b>HEAD TRIM</b> 	T167FR/10	10'-0"	5 7/8"	4.65			
<b>BASE TRIM – RECESSED</b> 	T160FR/10	10'-0"	5 3/8"	4.26			
	T160FR/20	20'-0"	5 3/8"	8.58			
<b>BASE TRIM – FLUSH</b> 	T161FR/10	10'-0"	6"	4.75			
	T161FR/20	20'-2"	6"	9.58			
<b>SILL / DRIP TRIM</b> 	T162FR/10	10'-0"	7"	4.75			
	T162FR/20	20'-2"	7"	9.58			

Kynar 500 ® Flashing – 24Ga Typ.  
 Galvalume® and SMP Flashing – 26Ga Typ.  
 Galvalume® = Acrylic Coated Galvalume  
 Galvalume is a trademark of BIEC , Inc.

**Austin – Headquarters / Sales Office**  
 830 Sagebrush Dr Austin, Texas 78758  
 (512) 452-1515 (800) 428-7412  
 Fax (512) 833-7499

www.ctmrs.com  
 email: info@ctmrs.com

**Seguin – Plant / Sales Office**  
 720 West IH 10 Seguin, Texas 78155  
 (830) 379-3600 (877) 622-8677  
 Fax (830) 379-8753

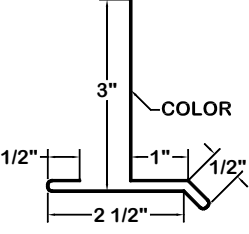
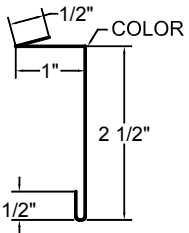
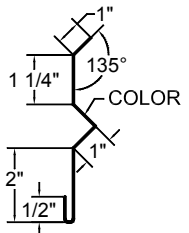
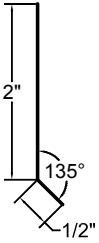

ITEM	DESCRIPTION				
<p><b>SILL WITH SOFFIT</b></p> 	PART NUMBER	LENGTH	GIRTH	WEIGHT	
	T320FR/10	10'-0"	8"	6.33	
<p><b>COUNTERFLASH</b></p>  <p>SPECIFY ANGLE OR ROOF SLOPE</p>	PART NUMBER	LENGTH	GIRTH	WEIGHT	
	T321/10 T321/20	10'-0" 20'-2"	4 1/2" 4 1/2"	3.56 7.18	
<p><b>FLUSH MOUNT COUNTERFLASH</b></p>  <p>SPECIFY ANGLE OR ROOF SLOPE</p>	PART NUMBER	LENGTH	GIRTH	WEIGHT	
	T322/10	10'-0"	6 3/4"	5.34	
<p><b>CONTINUOUS CLEAT</b></p> 	PART NUMBER	LENGTH	GIRTH	WEIGHT	
	T20/10	10'-0"	2 1/2"	1.98	
<p>Kynar 500 ® Flashing – 24Ga Typ.                      Galvalume® and SMP Flashing – 26Ga Typ.                      Galvalume® = Acrylic Coated Galvalume                      Galvalume is a trademark of BIEC , Inc.</p>					

**Austin – Headquarters / Sales Office**  
 830 Sagebrush Dr Austin, Texas 78758  
 (512) 452-1515 (800) 428-7412  
 Fax (512) 833-7499

www.ctmrs.com  
 email: info@ctmrs.com

**Seguin – Plant / Sales Office**  
 720 West IH 10 Seguin, Texas 78155  
 (830) 379-3600 (877) 622-8677  
 Fax (830) 379-8753

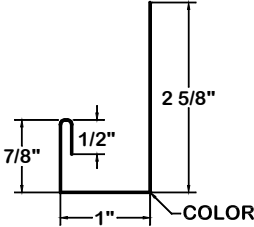
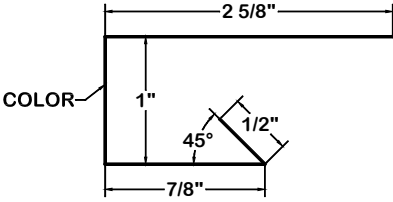
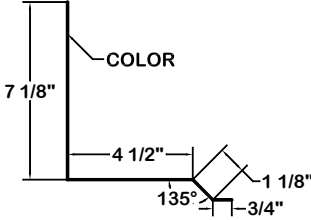
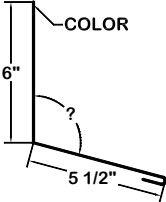

ITEM	DESCRIPTION						
	PART NUMBER	LENGTH	GIRTH	WEIGHT			
<b>HEAD TRIM / J CHANNEL</b> 	T165FR/10	10'-0"	5"	3.96			
	<p>2 5/8"</p> <p>1/2"</p> <p>1"</p> <p>COLOR</p>						
<b>JAMB TRIM</b> 	T168FR/10	10'-0"	5"	3.51			
	<p>COLOR</p> <p>1"</p> <p>45°</p> <p>1/2"</p> <p>7/8"</p>						
<b>SIDEWALL / PARAPET RAKE TRIM</b> 	T169FR/10	10'-0"	13 1/2"	10.69			
	T169FR/20	20'-2"	13 1/2"	21.55			
<p>COLOR</p> <p>7 1/8"</p> <p>4 1/2"</p> <p>135°</p> <p>1 1/8"</p> <p>3/4"</p> <p>SPECIFY ANGLE OR ROOF SLOPE</p>							
<b>ENDWALL / PARAPET HIGH EAVE TRIM 6 X 5 1/2</b> 	T170/10	10'-0"	12"	9.50			
	T170/20	20'-2"	12"	19.16			
<p>COLOR</p> <p>6"</p> <p>?</p> <p>5 1/2"</p> <p>SPECIFY ANGLE OR ROOF SLOPE</p>							
<p>Kynar 500 ® Flashing – 24Ga Typ.                      Galvalume® and SMP Flashing – 26Ga Typ.                      Galvalume® = Acrylic Coated Galvalume                      Galvalume is a trademark of BIEC , Inc.</p>							

**Austin – Headquarters / Sales Office**  
 830 Sagebrush Dr Austin, Texas 78758  
 (512) 452-1515 (800) 428-7412  
 Fax (512) 833-7499

www.ctmrs.com  
 email: info@ctmrs.com

**Seguin – Plant / Sales Office**  
 720 West IH 10 Seguin, Texas 78155  
 (830) 379-3600 (877) 622-8677  
 Fax (830) 379-8753

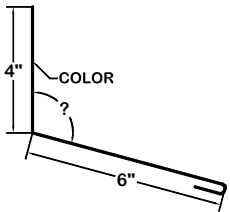
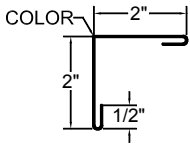
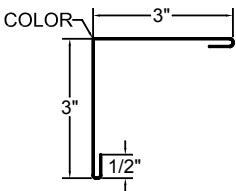
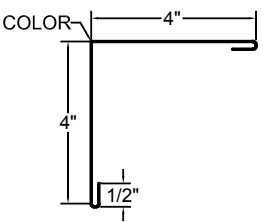

ITEM	DESCRIPTION						
	PART NUMBER	LENGTH	GIRTH	WEIGHT			
<b>ENDWALL / PARAPET HIGH EAVE TRIM 4 X 6</b>  SPECIFY ANGLE OR ROOF SLOPE	T171/10	10'-0"	10 1/2"	8.31			
	T171/20	20'-2"	10 1/2"	16.76			
<b>2 X 2 OUTSIDE ANGLE</b> 	T180/10	10'-0"	5"	3.96			
	T180/20	20'-2"	5"	7.98			
<b>3 X 3 OUTSIDE ANGLE</b> 	T181/10	10'-0"	7"	5.54			
	T181/20	20'-2"	7"	11.18			
<b>4 X 4 OUTSIDE ANGLE</b> 	T182/10	10'-0"	9"	7.13			
	T182/20	20'-2"	9"	14.37			
Kynar 500 ® Flashing – 24Ga Typ. Galvalume® and SMP Flashing – 26Ga Typ. Galvalume® = Acrylic Coated Galvalume Galvalume is a trademark of BIEC , Inc.							

**Austin – Headquarters / Sales Office**  
 830 Sagebrush Dr Austin, Texas 78758  
 (512) 452-1515 (800) 428-7412  
 Fax (512) 833-7499

www.ctmrs.com  
 email: info@ctmrs.com

**Seguin – Plant / Sales Office**  
 720 West IH 10 Seguin, Texas 78155  
 (830) 379-3600 (877) 622-8677  
 Fax (830) 379-8753



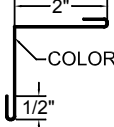
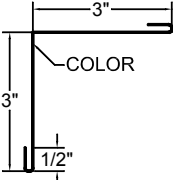
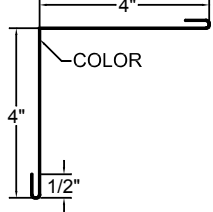
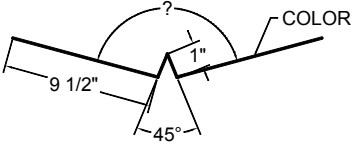

ITEM	DESCRIPTION						
	PART NUMBER	LENGTH	GIRTH	WEIGHT			
<b>2 X 2 INSIDE ANGLE</b>  	T183/10	10'-0"	5"	3.96			
	T183/20	20'-2"	5"	7.98			
<b>3 X 3 INSIDE ANGLE</b>  	T184/10	10'-0"	7"	5.54			
	T184/20	20'-2"	7"	11.18			
<b>4 X 4 INSIDE ANGLE</b>  	T185/10	10'-0"	9"	7.13			
	T185/20	20'-2"	9"	14.37			
<b>STANDARD VALLEY</b>    SPECIFY ANGLE OR ROOF SLOPE	T200/10	10'-0"	20 13/16"	16.63			
	T200/20	20'-2"	20 13/16"	33.53			
Kynar 500 ® Flashing – 24Ga Typ. Galvalume® and SMP Flashing – 26Ga Typ. Galvalume® = Acrylic Coated Galvalume Galvalume is a trademark of BIEC , Inc.							

**Austin – Headquarters / Sales Office**  
 830 Sagebrush Dr Austin, Texas 78758  
 (512) 452-1515 (800) 428-7412  
 Fax (512) 833-7499

www.ctmrs.com  
 email: info@ctmrs.com

**Seguin – Plant / Sales Office**  
 720 West IH 10 Seguin, Texas 78155  
 (830) 379-3600 (877) 622-8677  
 Fax (830) 379-8753

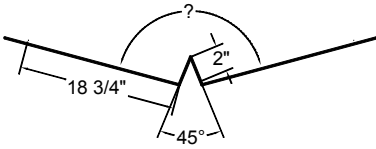
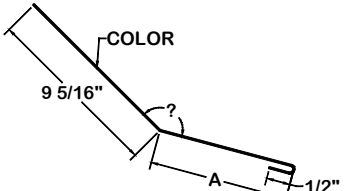
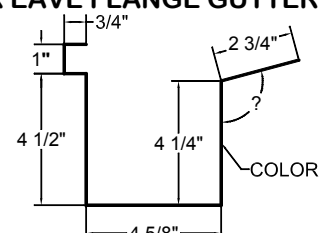
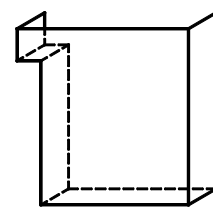

ITEM	DESCRIPTION							
	PART NUMBER	LENGTH	GIRTH	WEIGHT				
<b>EXTENDED VALLEY</b>  SPECIFY ANGLE OR ROOF SLOPE	T202/10	10'-0"	41 1/2"	32.85				
	<b>SLOPE TRANSITION / PITCH CHANGE</b>  SPECIFY ANGLE OR ROOF SLOPE							
<b>BOX EAVE FLANGE GUTTER</b>  SPECIFY ANGLE OR ROOF SLOPE	T197FR/10	10'-0"	18 5/8"	14.15				
	T197FR/20	20'-2"	18 5/8"	28.54				
	T323/10	8"	10'-0"	20 13/16"	16.48			
	T323/20	8"	20'-2"	20 13/16"	33.23			
	T324/10	11"	10'-0"	23 13/16"	18.85			
	T324/20	11"	20'-2"	23 13/16"	38.02			
<b>GUTTER END - BOX GUTTER</b> 	T197FR/10	10'-0"	18 5/8"	14.15				
	T197FR/20	20'-2"	18 5/8"	28.54				
	T199	N/A	N/A	0.20				

Kynar 500® Flashing – 24Ga Typ.  
 Galvalume® and SMP Flashing – 26Ga Typ.  
 Galvalume® = Acrylic Coated Galvalume  
 Galvalume is a trademark of BIEC, Inc.

**Austin – Headquarters / Sales Office**  
 830 Sagebrush Dr Austin, Texas 78758  
 (512) 452-1515 (800) 428-7412  
 Fax (512) 833-7499

www.ctmrs.com  
 email: info@ctmrs.com

**Seguin – Plant / Sales Office**  
 720 West IH 10 Seguin, Texas 78155  
 (830) 379-3600 (877) 622-8677  
 Fax (830) 379-8753

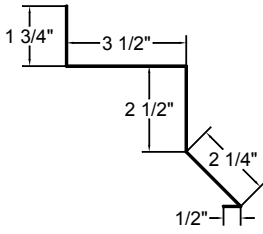
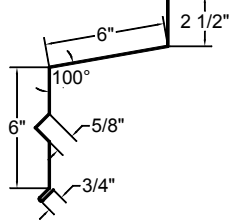
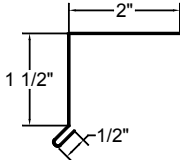
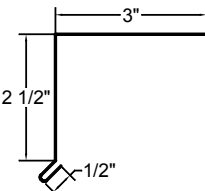
ITEM	DESCRIPTION						
	PART NUMBER	LENGTH	GIRTH	WEIGHT			
<b>NATIONAL TRACK COVER</b> 	T227/10	10'-0"	10 1/2"	7.92			
	T227/20	14'-2"	10 1/2"	11.38			
<b>SLIDING DOOR HOOD</b> 	T228/10	10'-0"	16"	7.49			
	T228/142	14'-2"	16"	10.74			
<b>EAVE TRIM 2 X 2</b>  SPECIFY ANGLE OR ROOF SLOPE	T300/10	10'-0"	4 1/2"	3.56			
	T300/20	20'-2"	4 1/2"	7.18			
<b>EAVE TRIM 3 X 3</b>  SPECIFY ANGLE OR ROOF SLOPE	T301/10	10'-0"	6 1/2"	5.15			
	T301/20	20'-2"	6 1/2"	10.38			
Kynar 500 ® Flashing – 24Ga Typ. Galvalume® and SMP Flashing – 26Ga Typ. Galvalume® = Acrylic Coated Galvalume Galvalume is a trademark of BIEC , Inc.							

**Austin – Headquarters / Sales Office**  
 830 Sagebrush Dr Austin, Texas 78758  
 (512) 452-1515 (800) 428-7412  
 Fax (512) 833-7499

www.ctmrs.com  
 email: info@ctmrs.com

**Seguin – Plant / Sales Office**  
 720 West IH 10 Seguin, Texas 78155  
 (830) 379-3600 (877) 622-8677  
 Fax (830) 379-8753

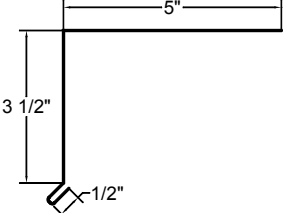
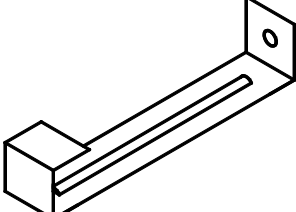
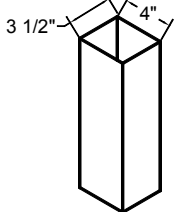
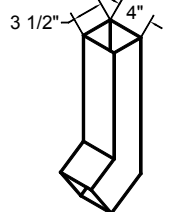

ITEM	DESCRIPTION				
<p><b>EAVE TRIM 4 X 5</b></p>  <p>SPECIFY ANGLE OR ROOF SLOPE</p>	PART NUMBER	LENGTH	GIRTH	WEIGHT	
	T302/10	10'-0"	9 1/2"	7.52	
	T302/20	20'-2"	9 1/2"	15.17	
<p><b>GUTTER HANGER</b></p>  <p>16 GA GALVANIZED</p>	PART NUMBER	LENGTH	WEIGHT		
	HANGER6	6"	0.23		
	HANGER7	7"	0.29		
	HANGER8	8"	0.35		
<p><b>STRAIGHT DOWNSPOUT</b></p> 	PART NUMBER	LENGTH	GIRTH	WEIGHT	
	T305/10	10'-0"	16 1/2"	11.88	
	T305/20	20'-2"	16 1/2"	23.95	
<p><b>DOWNSPOUT WITH ELBOW</b></p> 	PART NUMBER	LENGTH	GIRTH	WEIGHT	
	T306/10	10'-0"	16 1/2"	11.88	
	T306/20	20'-2"	16 1/2"	23.95	
<p>Kynar 500 ® Flashing – 24Ga Typ.                      Galvalume® and SMP Flashing – 26Ga Typ.                      Galvalume® = Acrylic Coated Galvalume                      Galvalume is a trademark of BIEC , Inc.</p>					

**Austin – Headquarters / Sales Office**  
 830 Sagebrush Dr Austin, Texas 78758  
 (512) 452-1515 (800) 428-7412  
 Fax (512) 833-7499

www.ctmrs.com  
 email: info@ctmrs.com

**Seguin – Plant / Sales Office**  
 720 West IH 10 Seguin, Texas 78155  
 (830) 379-3600 (877) 622-8677  
 Fax (830) 379-8753

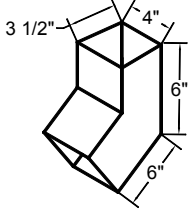
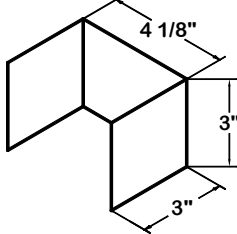
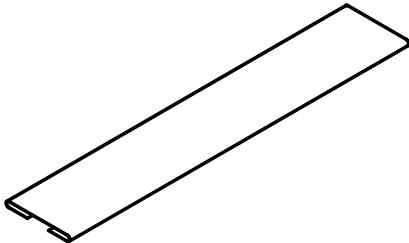
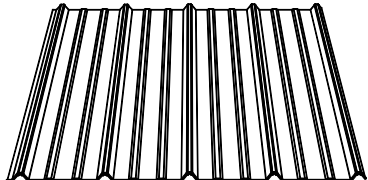

ITEM	DESCRIPTION				
<b>DOWNSPOUT ELBOW</b> 	PART NUMBER	LENGTH	GIRTH	WEIGHT	
	T310/45	12"	16 1/2"	1.38	
	T310/90	12"	16 1/2"	1.38	
T310/45 = 45 DEGREE ELBOW T310/90 = 90 DEGREE ELBOW					
<b>DOWNSPOUT STRAP</b> 	PART NUMBER	LENGTH	GIRTH	WEIGHT	
	T311	3	10 1/8"	0.20	
<b>UNIVERSAL STRAP</b> 	PART NUMBER	LENGTH	GIRTH	WEIGHT	
	T21/10	10'-0"	3"	2.38	
<b>LIGHT TRANSMITTING PANEL</b> 	PART NUMBER	TYPE		LENGTH	
	PFRFG1200	FIBERGLASS		12'-0"	
	PFRPCWHITE	POLYCARBONATE		12'-0"	
	PFRPCCLEAR	POLYCARBONATE		12'-0"	
	PFRPCSOFT	POLYCARBONATE		12'-0"	
Kynar 500® Flashing – 24Ga Typ. Galvalume® and SMP Flashing – 26Ga Typ. Galvalume® = Acrylic Coated Galvalume Galvalume is a trademark of BIEC , Inc.					

**Austin – Headquarters / Sales Office**  
 830 Sagebrush Dr Austin, Texas 78758  
 (512) 452-1515 (800) 428-7412  
 Fax (512) 833-7499

www.ctmrs.com  
 email: info@ctmrs.com

**Seguin – Plant / Sales Office**  
 720 West IH 10 Seguin, Texas 78155  
 (830) 379-3600 (877) 622-8677  
 Fax (830) 379-8753

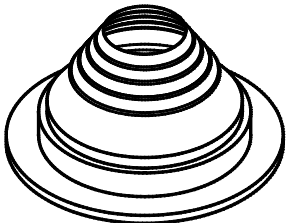
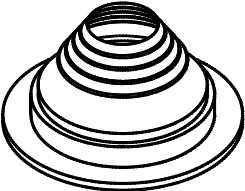
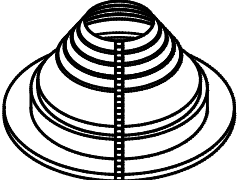
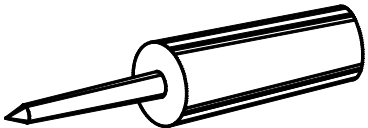

ITEM	DESCRIPTION				PRICE	
<b>PIPE FLASHING – GRAY EPDM</b> 	<b>PART NUMBER</b>	<b>PIPE SIZE RANGE</b>	<b>BASE DIMENSION</b>			
	PFG000	1/4" TO 1 1/8"	3 1/2"			
	PFG001	1/4" TO 2"	4 3/4"			
	PFG002	1 3/4" TO 4"	6 1/4"			
	PFG003	1/4" TO 4"	7 3/4"			
	PFG004	3" TO 6"	9 1/4"			
	PFG005	4" TO 7"	10 3/4"			
	PFG007	6" TO 11"	14 1/2"			
	PFG008	7" TO 13"	16 1/2"			
	PFG009	10" TO 18"	25 3/8"			
PFG010	16" TO 24"	39 1/2" x 35" sq.				
EPDM RUBBER SERVICE TEMPERATURE –65F TO 250F. IF SLOPE IS MORE THAN 20 DEGREES USE NEXT SIZE UP.						
<b>PIPE FLASHING – RED SILICONE (HIGH TEMPERATURE)</b> 	<b>PART NUMBER</b>	<b>PIPE SIZE RANGE</b>	<b>BASE DIMENSION</b>			
	PFS003	1/4" TO 4"	7 3/4"			
	PFS005	4" TO 7"	10 3/4"			
	PFS008	7" TO 13"	16 1/2"			
	PFS009	10" TO 18"	25 3/8"			
SILICONE SERVICE TEMPERATURE –40F TO 350F. IF SLOPE IS MORE THAN 20 DEGREES USE NEXT SIZE UP.						
<b>RETROFIT PIPE FLASHING – GRAY EPDM</b> 	<b>PART NUMBER</b>	<b>PIPE SIZE RANGE</b>	<b>BASE DIMENSION</b>			
	PFG801	3/4" TO 2 3/4"	6 1/4"			
	PFG802	2" TO 7 1/4"	10 3/4"			
	PFG803	3 1/4" TO 10"	14 1/2"			
EPDM RUBBER SERVICE TEMPERATURE –65F TO 250F. IF SLOPE IS MORE THAN 20 DEGREES USE NEXT SIZE UP.						
<b>CAULK SEALER - TUBE</b>   10 OZ TUBE	<b>PART NUMBER</b>	<b>TYPE</b>	<b>COLOR</b>	<b>CARTON QUANTITY</b>	<b>CARTON WEIGHT</b>	
	TCWM61111CLEAR	ACRYLIC	CLEAR	12	15	
	TCWM62611GRAY	POLYURETHANE	GRAY	12	15	
	TCWM61141BRONZE	POLYURETHANE	BRONZE	12	15	
	TCWM61611BEIGE	POLYURETHANE	BEIGE	12	15	
	TCWM61011WHITE	POLYURETHANE	WHITE	12	15	
	Kynar 500 @ Flashing – 24Ga Typ. Galvalume® and SMP Flashing – 26Ga Typ. Galvalume® = Acrylic Coated Galvalume Galvalume is a trademark of BIEC , Inc.					

**Austin – Headquarters / Sales Office**  
 830 Sagebrush Dr Austin, Texas 78758  
 (512) 452-1515 (800) 428-7412  
 Fax (512) 833-7499

www.ctmrs.com  
 email: info@ctmrs.com

**Seguin – Plant / Sales Office**  
 720 West IH 10 Seguin, Texas 78155  
 (830) 379-3600 (877) 622-8677  
 Fax (830) 379-8753

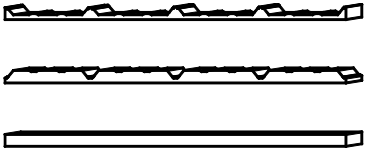
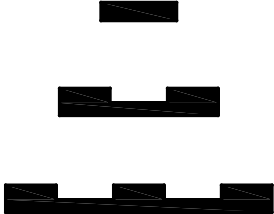
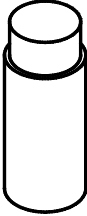

## Central Texas Metal Roofing Supply Co., Inc

ITEM	DESCRIPTION				PRICE	
<b>CLOSURE STRIP</b>  	PART NUMBER	SIZE	CARTON QUANTITY	CARTON WEIGHT		
	CGFROUTSIDE OUTSIDE / TOP	36"	100 PCS	4.09		
	CGFRINSIDE INSIDE/BOTTOM	36"	100 PCS	8.32		
	CGHIP0875 UNIVERSAL	1" X 7/8" X 40"	100 PCS	9.27		
<b>BUTYL TAPE SEALER</b>  	PART NUMBER	SIZE	CARTON QUANTITY	CARTON WEIGHT		
	TAPEBUTYL0375	3/8" X 3/32" X 45'	24 ROLLS	45.20		
	TAPEBUTYL0875	7/8" X 3/16" X 25'	14 ROLLS	60.75		
	TAPE250	2 1/2" X 3/16" X 20'	6 ROLLS	23.00		
<b>TOUCHUP PAINT</b>  	PART NUMBER	SIZE	TYPE			
	PNTK2	2 OZ	KYNAR - BRUSH ON (BRUSH NOT INCLUDED)			
	PNTS425	4.25 OZ	SMP - BRUSH ON			
Kynar 500 ® Flashing – 24Ga Typ. Galvalume® and SMP Flashing – 26Ga Typ. Galvalume® = Acrylic Coated Galvalume Galvalume is a trademark of BIEC , Inc.						

**Austin – Headquarters / Sales Office**  
 830 Sagebrush Dr Austin, Texas 78758  
 (512) 452-1515 (800) 428-7412  
 Fax (512) 833-7499

www.ctmrs.com  
 email: info@ctmrs.com

**Seguin – Plant / Sales Office**  
 720 West IH 10 Seguin, Texas 78155  
 (830) 379-3600 (877) 622-8677  
 Fax (830) 379-8753



# Trim Notes

Central Texas Metal Roofing Supply Co., Inc

### TRIM NOTES

1. All Galvalume® and SMP Painted standard trim is 26 gauge.
  2. All Kynar 500® and Metallic Kynar 500® standard trim is 24 gauge.
  3. 24 gauge Galvalume® trim is available - please request a quote.
  4. All painted trim is fabricated with protective film to prevent scratches.  
If you prefer trim without plastic film, please indicate this at the time of order.
- Please request a quote for custom trim in length of 20'-02" up to 28'-0". Minimum order required.

### DELIVERY

- |   |  |
|---|--|
| <ol style="list-style-type: none"> <li>1. Stock colors (See Color Chart)</li> <li>2. Non stock colors, gauges and metals</li> </ol> | <p>Approximately 2 Working Days<br/>Please Inquire with CTMRS sales staff.</p> |
|---|--|

Galvalume® and Acrylic Coated Galvalume® are unfinished products. Shade variations, color difference and a rate of weathering in unfinished product such as Galvalume® and Acrylic Coated Galvalume® should be anticipated and are not a cause for rejection. Use a pre-painted finish if uniform weathering and appearance is crucial. Oil canning is inherent to roll formed products and might not be a reason for rejection.

**Austin – Headquarters / Sales Office**  
 830 Sagebrush Dr Austin, Texas 78758  
 (512) 452-1515 (800) 428-7412  
 Fax (512) 833-7499

www.ctmrs.com  
 email: info@ctmrs.com

**Seguin – Plant / Sales Office**  
 720 West IH 10 Seguin, Texas 78155  
 (830) 379-3600 (877) 622-8677  
 Fax (830) 379-8753