

Central Texas Metal Roofing Supply Co., Inc

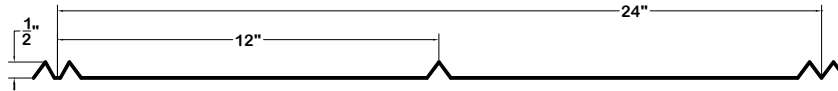

GAUGE	PANEL	FINISH	NET COVERAGE	SHEET WIDTH	WEIGHT PER SQ.	PRICE PER SQ.	PRICE PER LINEAR FOOT
26	5 Vee	GALVALUME®	24"	26 3/8"	95.00		

PANEL PRICING:

1. Price per Square is based on 26 3/8" sheet width.
2. Add \$ 2.00 per each panel less than 3'-0".
3. Add \$ 40.00 set up charge for reverse run panels. (Color upside down).
4. Panels longer than 40' will have a 10% surcharge.

PACKAGING PRICING:

- | | | |
|---|--|------------------|
| 1. Maximum weight of one bundle is 3,000 pounds or 75 panels. | | |
| 2. Standard packaging - band with guard, top waster sheet | \$10.00/bundle | \$20.00 over 16' |
| 3. Block and band, top waster sheet | \$15.00/bundle | \$25.00 over 16' |
| 4. Block and band, top and bottom waster sheet | \$25.00/bundle | \$40.00 over 16' |
| 5. LTL Crating - block and band, top and bottom waster sheet | \$5.00/linear foot, minimum charge \$40.00 | |

Orders less than 5 panels will require block and band , top waster sheet

Galvalume® and Acrylic Coated Galvalume® are unfinished products.
Shade variations, color difference and a rate of weathering in unfinished product such as Galvalume® and Acrylic Coated Galvalume® should be anticipated and are not a cause for rejection.
Use a pre-painted finish if uniform weathering and appearance is crucial.

Austin – Headquarters / Sales Office
 830 Sagebrush Dr Austin, Texas 78758
 (512) 452-1515 (800) 428-7412
 Fax (512) 833-7499

www.ctmrs.com
 email: info@ctmrs.com

Seguin – Plant / Sales Office
 720 West IH 10 Seguin, Texas 78155
 (830) 379-3600 (877) 622-8677
 Fax (830) 379-8753

Central Texas Metal Roofing Supply Co., Inc

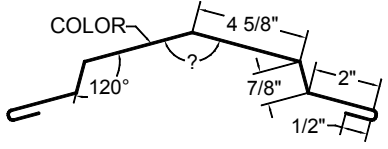
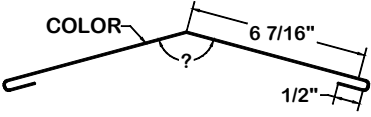
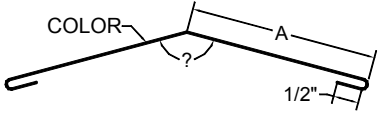
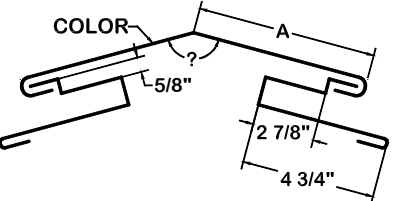
ITEM	DESCRIPTION				PRICE PER EACH		
	PART NUMBER	LENGTH	GIRTH	WEIGHT			
UNIVERSAL RIDGE CAP  <p>COLOR</p> <p>120°</p> <p>4 5/8"</p> <p>7/8"</p> <p>1/2"</p>	T100/10	10'-0"	16"	12.67			
	T100/20	20'-2"	16"	25.54			
SPECIFY ANGLE OR ROOF SLOPE							
HIP / RIDGE CAP  <p>COLOR</p> <p>6 7/16"</p> <p>1/2"</p>	T101/10	10'-0"	13 7/8"	10.89			
	T101/20	20'-2"	13 7/8"	21.95			
SPECIFY ANGLE OR ROOF SLOPE							
HIP / RIDGE CAP - EXTENDED  <p>COLOR</p> <p>A</p> <p>1/2"</p>	T102/10	10'-0"	16"	12.67			
	T102/20	20'-2"	16"	25.54			
<p>T103/10</p> <p>T103/20</p> <p>T102 - A = 7 1/2"</p> <p>T103 - A = 11 1/2"</p>	T103/10	10'-0"	24"	19.00			
	T103/20	20'-2"	24"	38.32			
SPECIFY ANGLE OR ROOF SLOPE							
VENTED RIDGE CAP  <p>COLOR</p> <p>A</p> <p>5/8"</p> <p>2 7/8"</p> <p>4 3/4"</p>	T110/10	10'-0"	38 3/4"	30.68			
	<p>VENTED AREA = 4.62SQ IN/LF</p> <p>DIM "A" DEPENDS ON THE ROOF SLOPE.</p> <p>SLOPE DIM "A"</p> <p>1/4 1/12 to 6 1/12 6 7/16"</p> <p>6 1/8 1/12 to 9 1/12 7 1/2"</p> <p>9 1/8 1/12 to 12/12 8 1/2"</p>						
SPECIFY ANGLE OR ROOF SLOPE							
<p>Kynar 500 ® Flashing – 24Ga Typ.</p> <p>Galvalume® and SMP Flashing – 26Ga Typ.</p> <p>Galvalume® = Acrylic Coated Galvalume</p> <p>Galvalume is a trademark of BIEC , Inc.</p>							

Austin – Headquarters / Sales Office
 830 Sagebrush Dr Austin, Texas 78758
 (512) 452-1515 (800) 428-7412
 Fax (512) 833-7499

www.ctmrs.com
 email: info@ctmrs.com

Seguin – Plant / Sales Office
 720 West IH 10 Seguin, Texas 78155
 (830) 379-3600 (877) 622-8677
 Fax (830) 379-8753

Central Texas Metal Roofing Supply Co., Inc

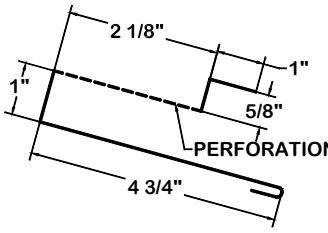
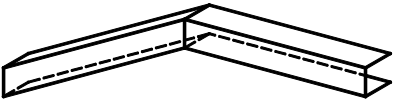
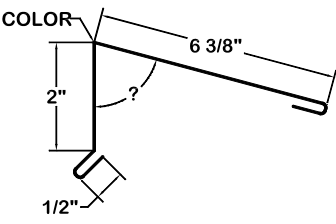
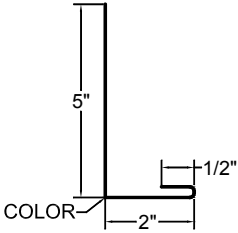
ITEM	DESCRIPTION				PRICE PER EACH		
	PART NUMBER	LENGTH	GIRTH	WEIGHT			
VENTED SKIRT 	T400/10	10'-0"	10"	8.21			
	VENTED AREA = 2.31 SQ IN/LF						
VENTED RIDGE END CAP 	T151/10	18"	N/A	.15			
	PRE NOTCHED FOR ADJUSTMENT TO ROOF SLOPE						
PEAK FLASHING / HIGH SIDE EAVE 	T152TR/10	10'-0"	9 7/8"	8.02			
	T152TR/20	20'-2"	9 7/8"	16.16			
SPECIFY ANGLE OR ROOF SLOPE							
FASCIA TRIM 	T154/10	10'-0"	7 1/2"	5.94			
	T154/20	20'-2"	7 1/2"	11.97			
Kynar 500 ® Flashing – 24Ga Typ. Galvalume® and SMP Flashing – 26Ga Typ. Galvalume® = Acrylic Coated Galvalume Galvalume is a trademark of BIEC , Inc.							

Austin – Headquarters / Sales Office
 830 Sagebrush Dr Austin, Texas 78758
 (512) 452-1515 (800) 428-7412
 Fax (512) 833-7499

www.ctmrs.com
 email: info@ctmrs.com

Seguin – Plant / Sales Office
 720 West IH 10 Seguin, Texas 78155
 (830) 379-3600 (877) 622-8677
 Fax (830) 379-8753

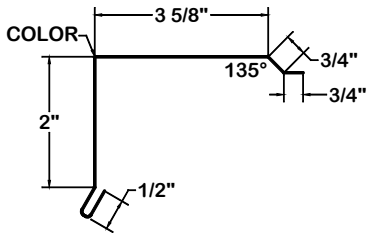
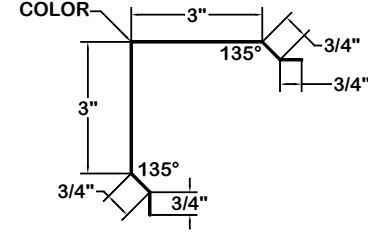
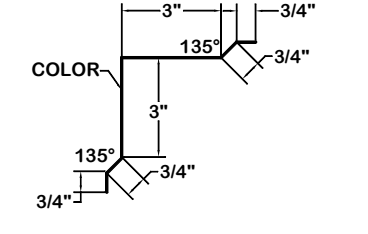
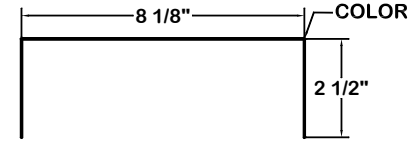
ITEM	DESCRIPTION				PRICE PER EACH		
	PART NUMBER	LENGTH	GIRTH	WEIGHT			
RAKE TRIM 	T155TR/10	10'-0"	8 1/8"	6.63			
	T155TR/20	20'-2"	8 1/8"	13.37			
OUTSIDE CORNER TRIM 	T157TR/10	10'-0"	9"	7.13			
	T157TR/20	20'-2"	9"	14.37			
INSIDE CORNER TRIM 	T158TR/10	10'-0"	9"	7.13			
	T158TR/20	20'-2"	9"	14.37			
JAMB / HEAD CAP 	T159/10	10'-0"	13 1/8"	10.39			
	T159/20	20'-2"	13 1/8"	20.95			
Kynar 500 ® Flashing – 24Ga Typ. Galvalume® and SMP Flashing – 26Ga Typ. Galvalume® = Acrylic Coated Galvalume Galvalume is a trademark of BIEC , Inc.							

Austin – Headquarters / Sales Office
 830 Sagebrush Dr Austin, Texas 78758
 (512) 452-1515 (800) 428-7412
 Fax (512) 833-7499

www.ctmrs.com
 email: info@ctmrs.com

Seguin – Plant / Sales Office
 720 West IH 10 Seguin, Texas 78155
 (830) 379-3600 (877) 622-8677
 Fax (830) 379-8753

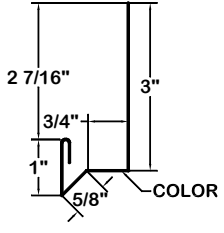
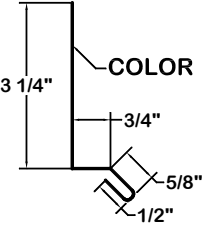
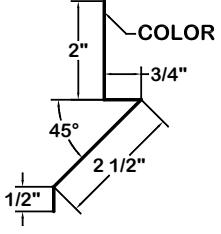
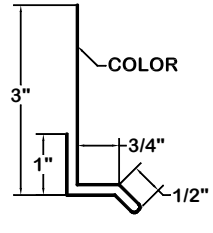

Central Texas Metal Roofing Supply Co., Inc

ITEM	DESCRIPTION				PRICE PER EACH		
	PART NUMBER	LENGTH	GIRTH	WEIGHT			
HEAD TRIM 	T167TR/10	10'-0"	5 7/8"	4.65			
BASE TRIM – RECESSED 	T160TR/10	10'-0"	5 1/8"	4.06			
	T160TR/20	20'-0"	5 1/8"	8.18			
BASE TRIM – FLUSH 	T161TR/10	10'-0"	5 3/4"	4.55			
	T161TR/20	20'-2"	5 3/4"	9.18			
SILL / DRIP TRIM 	T162TR/10	10'-0"	6 1/2"	4.75			
	T162TR/20	20'-2"	6 1/2"	9.58			
Kynar 500 ® Flashing – 24Ga Typ. Galvalume® and SMP Flashing – 26Ga Typ. Galvalume® = Acrylic Coated Galvalume Galvalume is a trademark of BIEC , Inc.							

Austin – Headquarters / Sales Office
 830 Sagebrush Dr Austin, Texas 78758
 (512) 452-1515 (800) 428-7412
 Fax (512) 833-7499

www.ctmrs.com
 email: info@ctmrs.com

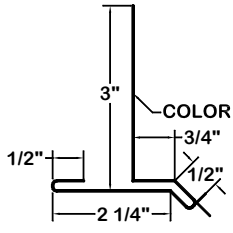
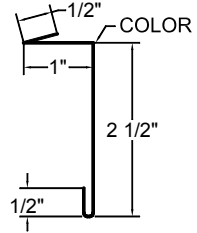
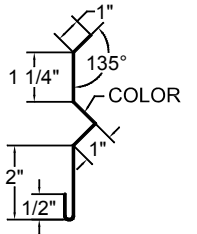
Seguin – Plant / Sales Office
 720 West IH 10 Seguin, Texas 78155
 (830) 379-3600 (877) 622-8677
 Fax (830) 379-8753

ITEM	DESCRIPTION						
	PART NUMBER	LENGTH	GIRTH	WEIGHT			
SILL WITH SOFFIT 	T320TR/10	10'-0"	7 1/2"	5.94			
COUNTERFLASH  <p>SPECIFY ANGLE OR ROOF SLOPE</p>	T321/10	10'-0"	4 1/2"	3.56			
	T321/20	20'-2"	4 1/2"	7.18			
FLUSH MOUNT COUNTERFLASH  <p>SPECIFY ANGLE OR ROOF SLOPE</p>	T322/10	10'-0"	6 3/4"	5.34			
CONTINUOUS CLEAT 	T20/10	10'-0"	2 1/2"	1.98			
<p>Kynar 500 ® Flashing – 24Ga Typ. Galvalume® and SMP Flashing – 26Ga Typ. Galvalume® = Acrylic Coated Galvalume Galvalume is a trademark of BIEC , Inc.</p>							

Austin – Headquarters / Sales Office
 830 Sagebrush Dr Austin, Texas 78758
 (512) 452-1515 (800) 428-7412
 Fax (512) 833-7499

www.ctmrs.com
 email: info@ctmrs.com

Seguin – Plant / Sales Office
 720 West IH 10 Seguin, Texas 78155
 (830) 379-3600 (877) 622-8677
 Fax (830) 379-8753

Central Texas Metal Roofing Supply Co., Inc

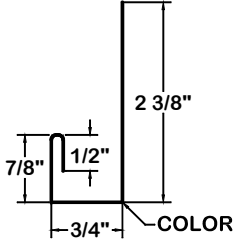
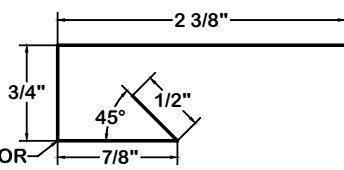
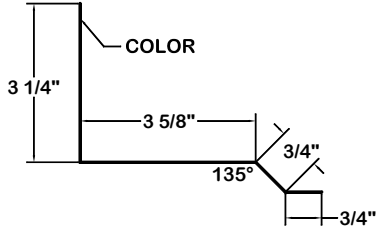
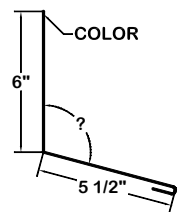
ITEM	DESCRIPTION				PRICE PER EACH		
	PART NUMBER	LENGTH	GIRTH	WEIGHT			
HEAD TRIM / J CHANNEL 	T165TR/10	10'-0"	4 1/2"	3.76			
	JAMB TRIM 						
SIDEWALL / PARAPET RAKE TRIM  SPECIFY ANGLE OR ROOF SLOPE	T169TR/10	10'-0"	8 3/8"	6.63			
	T169TR/20	20'-2"	8 3/8"	13.37			
ENDWALL / PARAPET HIGH EAVE TRIM 6 X 5 1/2  SPECIFY ANGLE OR ROOF SLOPE	T170/10	10'-0"	12"	9.50			
	T170/20	20'-2"	12"	19.16			
Kynar 500 ® Flashing – 24Ga Typ. Galvalume® and SMP Flashing – 26Ga Typ. Galvalume® = Acrylic Coated Galvalume Galvalume is a trademark of BIEC , Inc.							

Austin – Headquarters / Sales Office
 830 Sagebrush Dr Austin, Texas 78758
 (512) 452-1515 (800) 428-7412
 Fax (512) 833-7499

www.ctmrs.com
 email: info@ctmrs.com

Seguin – Plant / Sales Office
 720 West IH 10 Seguin, Texas 78155
 (830) 379-3600 (877) 622-8677
 Fax (830) 379-8753

Central Texas Metal Roofing Supply Co., Inc

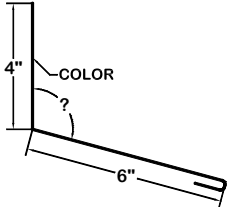
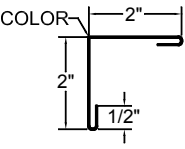
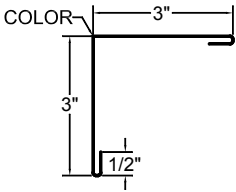
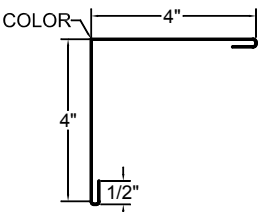
ITEM	DESCRIPTION						
	PART NUMBER	LENGTH	GIRTH	WEIGHT			
ENDWALL / PARAPET HIGH EAVE TRIM 4 X 6  SPECIFY ANGLE OR ROOF SLOPE	T171/10	10'-0"	10 1/2"	8.31			
	T171/20	20'-2"	10 1/2"	16.76			
2 X 2 OUTSIDE ANGLE 	T180/10	10'-0"	5"	3.96			
	T180/20	20'-2"	5"	7.98			
3 X 3 OUTSIDE ANGLE 	T181/10	10'-0"	7"	5.54			
	T181/20	20'-2"	7"	11.18			
4 X 4 OUTSIDE ANGLE 	T182/10	10'-0"	9"	7.13			
	T182/20	20'-2"	9"	14.37			
Kynar 500 ® Flashing – 24Ga Typ. Galvalume® and SMP Flashing – 26Ga Typ. Galvalume® = Acrylic Coated Galvalume Galvalume is a trademark of BIEC , Inc.							

Austin – Headquarters / Sales Office
 830 Sagebrush Dr Austin, Texas 78758
 (512) 452-1515 (800) 428-7412
 Fax (512) 833-7499

www.ctmrs.com
 email: info@ctmrs.com

Seguin – Plant / Sales Office
 720 West IH 10 Seguin, Texas 78155
 (830) 379-3600 (877) 622-8677
 Fax (830) 379-8753

Central Texas Metal Roofing Supply Co., Inc

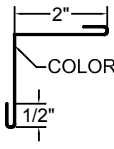
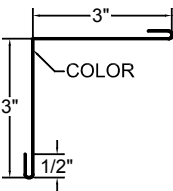
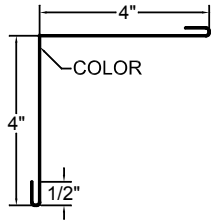
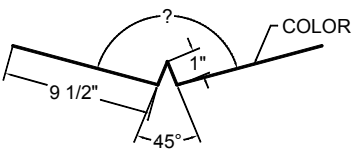
ITEM	DESCRIPTION						
	PART NUMBER	LENGTH	GIRTH	WEIGHT			
2 X 2 INSIDE ANGLE 	T183/10	10'-0"	5"	3.96			
	T183/20	20'-2"	5"	7.98			
3 X 3 INSIDE ANGLE 	T184/10	10'-0"	7"	3.96			
	T184/20	20'-2"	7"	7.98			
4 X 4 INSIDE ANGLE 	T185/10	10'-0"	9"	7.13			
	T185/20	20'-2"	9"	14.37			
STANDARD VALLEY 	T200/10	10'-0"	20 13/16"	16.63			
	T200/20	20'-2"	20 13/16"	33.53			
SPECIFY ANGLE OR ROOF SLOPE							
Kynar 500 ® Flashing – 24Ga Typ. Galvalume® and SMP Flashing – 26Ga Typ. Galvalume® = Acrylic Coated Galvalume Galvalume is a trademark of BIEC , Inc.							

Austin – Headquarters / Sales Office
 830 Sagebrush Dr Austin, Texas 78758
 (512) 452-1515 (800) 428-7412
 Fax (512) 833-7499

www.ctmrs.com
 email: info@ctmrs.com

Seguin – Plant / Sales Office
 720 West IH 10 Seguin, Texas 78155
 (830) 379-3600 (877) 622-8677
 Fax (830) 379-8753

Central Texas Metal Roofing Supply Co., Inc

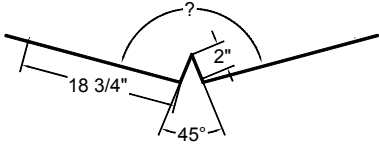
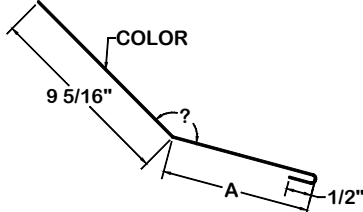
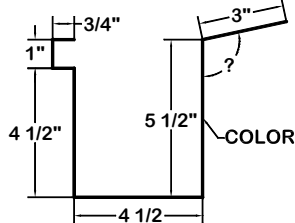
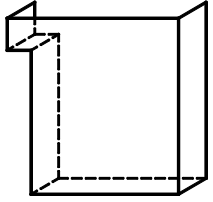
ITEM	DESCRIPTION						
	PART NUMBER	LENGTH	GIRTH	WEIGHT			
EXTENDED VALLEY  SPECIFY ANGLE OR ROOF SLOPE	T202/10	10'-0"	41 1/2"	32.85			
	SLOPE TRANSITION / PITCH CHANGE  SPECIFY ANGLE OR ROOF SLOPE						
BOX EAVE FLANGE GUTTER  SPECIFY ANGLE OR ROOF SLOPE	T197/10	10'-0"	20"	15.24			
	T197/20	20'-2"	20"	30.73			
GUTTER END - BOX GUTTER 	T199	N/A	N/A	0.20			
	Kynar 500 ® Flashing – 24Ga Typ. Galvalume® and SMP Flashing – 26Ga Typ. Galvalume® = Acrylic Coated Galvalume Galvalume is a trademark of BIEC , Inc.						

Austin – Headquarters / Sales Office
 830 Sagebrush Dr Austin, Texas 78758
 (512) 452-1515 (800) 428-7412
 Fax (512) 833-7499

www.ctmrs.com
 email: info@ctmrs.com

Seguin – Plant / Sales Office
 720 West IH 10 Seguin, Texas 78155
 (830) 379-3600 (877) 622-8677
 Fax (830) 379-8753

Central Texas Metal Roofing Supply Co., Inc

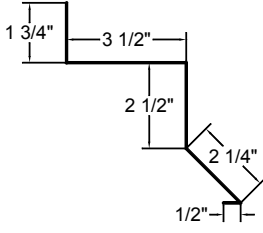
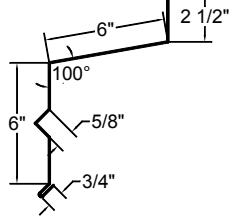
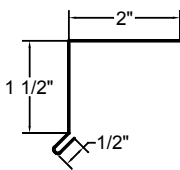
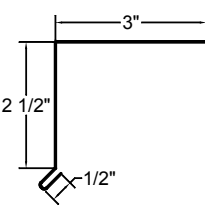
ITEM	DESCRIPTION						
	PART NUMBER	LENGTH	GIRTH	WEIGHT			
NATIONAL TRACK COVER 	T227/10	10'-0"	10 1/2"	7.92			
	T227/20	14'-2"	10 1/2"	11.38			
SLIDING DOOR HOOD 	T228/10	10'-0"	16"	7.49			
	T228/142	14'-2"	16"	10.74			
EAVE TRIM 2 X 2  SPECIFY ANGLE OR ROOF SLOPE	T300/10	10'-0"	4 1/2"	3.56			
	T300/20	20'-2"	4 1/2"	7.18			
EAVE TRIM 3 X 3  SPECIFY ANGLE OR ROOF SLOPE	T301/10	10'-0"	6 1/2"	5.15			
	T301/20	20'-2"	6 1/2"	10.38			
Kynar 500 ® Flashing – 24Ga Typ. Galvalume® and SMP Flashing – 26Ga Typ. Galvalume® = Acrylic Coated Galvalume Galvalume is a trademark of BIEC , Inc.							

Austin – Headquarters / Sales Office
 830 Sagebrush Dr Austin, Texas 78758
 (512) 452-1515 (800) 428-7412
 Fax (512) 833-7499

www.ctmrs.com
 email: info@ctmrs.com

Seguin – Plant / Sales Office
 720 West IH 10 Seguin, Texas 78155
 (830) 379-3600 (877) 622-8677
 Fax (830) 379-8753

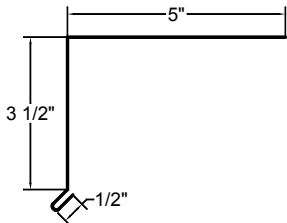
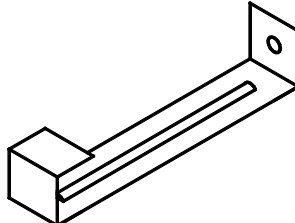
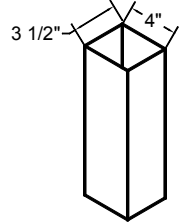
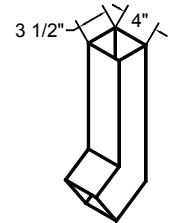
ITEM	DESCRIPTION						
	PART NUMBER	LENGTH	GIRTH	WEIGHT			
EAVE TRIM 4 X 5  SPECIFY ANGLE OR ROOF SLOPE	T302/10	10'-0"	9 1/2"	7.52			
	T302/20	20'-2"	9 1/2"	15.17			
GUTTER HANGER  16 GA GALVANIZED	T303/5	5"		0.23			
	T303/6	6"		0.29			
T303/7	7"		0.35				
STRAIGHT DOWNSPOUT 	T305/10	10'-0"	16 1/2"	11.88			
	T305/20	20'-2"	16 1/2"	23.95			
DOWNSPOUT WITH ELBOW 	T306/10	10'-0"	16 1/2"	11.88			
	T306/20	20'-2"	16 1/2"	23.95			
Kynar 500 ® Flashing – 24Ga Typ. Galvalume® and SMP Flashing – 26Ga Typ. Galvalume® = Acrylic Coated Galvalume Galvalume is a trademark of BIEC , Inc.							

Austin – Headquarters / Sales Office
 830 Sagebrush Dr Austin, Texas 78758
 (512) 452-1515 (800) 428-7412
 Fax (512) 833-7499

www.ctmrs.com
 email: info@ctmrs.com

Seguin – Plant / Sales Office
 720 West IH 10 Seguin, Texas 78155
 (830) 379-3600 (877) 622-8677
 Fax (830) 379-8753

Central Texas Metal Roofing Supply Co., Inc

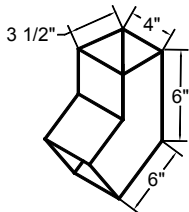
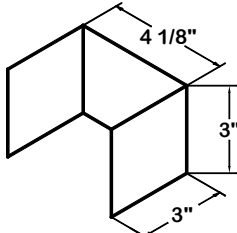
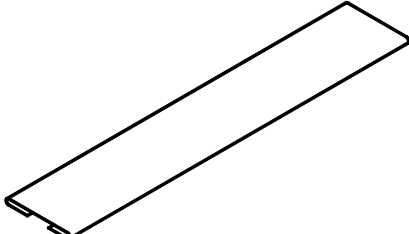
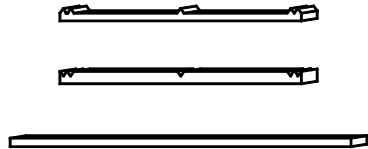
ITEM	DESCRIPTION						
	PART NUMBER	LENGTH	GIRTH	WEIGHT			
DOWNSPOUT ELBOW 	T310/45	12"	16 1/2"	1.38			
	T310/90	12"	16 1/2"	1.38			
T310/45 = 45 DEGREE ELBOW T310/90 = 90 DEGREE ELBOW							
DOWNSPOUT STRAP 	T311	3	10 1/8"	0.20			
UNIVERSAL STRAP 	T21/10	10'-0"	3"	2.38			
CLOSURE STRIP 	CG5VOUTSIDE OUTSIDE / TOP	36"	100 PCS	4.09			
	CG5VINSIDE INSIDE/BOTTOM	36"	100 PCS	8.32			
	CGHIP0625 UNIVERSAL	1" X 5/8" X 40"	100 PCS	9.27			
Kynar 500 ® Flashing – 24Ga Typ. Galvalume® and SMP Flashing – 26Ga Typ. Galvalume® = Acrylic Coated Galvalume Galvalume is a trademark of BIEC , Inc.							

Austin – Headquarters / Sales Office
 830 Sagebrush Dr Austin, Texas 78758
 (512) 452-1515 (800) 428-7412
 Fax (512) 833-7499

www.ctmrs.com
 email: info@ctmrs.com

Seguin – Plant / Sales Office
 720 West IH 10 Seguin, Texas 78155
 (830) 379-3600 (877) 622-8677
 Fax (830) 379-8753

Central Texas Metal Roofing Supply Co., Inc

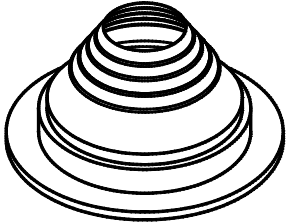
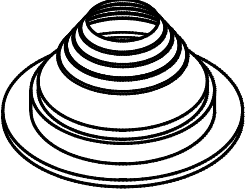
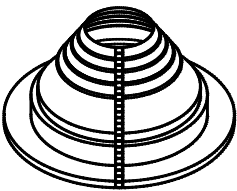
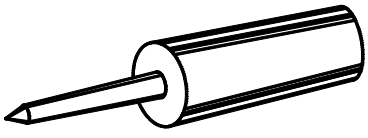
ITEM	DESCRIPTION					
PIPE FLASHING – GRAY EPDM 	PART NUMBER	PIPE SIZE RANGE	BASE DIMENSION			
	PFG000	¼" TO 1 1/8"	3 ½"			
	PFG001	¼" TO 2"	4 ¾"			
	PFG002	1 3/4" TO 4"	6 ¼"			
	PFG003	¼" TO 4"	7 ¾"			
	PFG004	3" TO 6"	9 ¼"			
	PFG005	4" TO 7"	10 ¾"			
	PFG007	6" TO 11"	14 ½"			
	PFG008	7" TO 13"	16 ½"			
	PFG009	10" TO 18"	25 3/8"			
	PFG010	16" TO 24"	39 ½" x 35" sq.			
EPDM RUBBER SERVICE TEMPERATURE –65F TO +250F. IF SLOPE IS MORE THAN 20 DEGREES USE NEXT SIZE UP.						
PIPE FLASHING – RED SILICONE (HIGH TEMPERATURE) 	PART NUMBER	PIPE SIZE RANGE	BASE DIMENSION			
	PFS003	¼" TO 4"	7 ¾"			
	PFS005	4" TO 7"	10 ¾"			
	PFS008	7" TO 13"	16 ½"			
	PFS009	10" TO 18"	25 3/8"			
SILICONE SERVICE TEMPERATURE –40F TO +350F. IF SLOPE IS MORE THAN 20 DEGREES USE NEXT SIZE UP.						
RETROFIT PIPE FLASHING – GRAY EPDM 	PART NUMBER	PIPE SIZE RANGE	BASE DIMENSION			
	PFG801	¾" TO 2 ¾"	6 ¼"			
	PFG802	2" TO 7 ¼"	10 ¾"			
	PFG803	3 ¼" TO 10"	14 ½"			
EPDM RUBBER SERVICE TEMPERATURE –65F TO +250F. IF SLOPE IS MORE THAN 20 DEGREES USE NEXT SIZE UP.						
CAULK SEALER - TUBE  10 OZ TUBE	PART NUMBER	TYPE	COLOR	CARTON QUANTITY	CARTON WEIGHT	
	TCWM61111CLEAR	ACRYLIC	CLEAR	12	15	
	TCWM62611GRAY	POLYURETHANE	GRAY	12	15	
	TCWM61141BRONZE	POLYURETHANE	BRONZE	12	15	
	TCWM61611BEIGE	POLYURETHANE	BEIGE	12	15	
	TCWM61011WHITE	POLYURETHANE	WHITE	12	15	
	Kynar 500 ® Flashing – 24Ga Typ. Galvalume® and SMP Flashing – 26Ga Typ. Galvalume® = Acrylic Coated Galvalume Galvalume is a trademark of BIEC , Inc.					

Austin – Headquarters / Sales Office
 830 Sagebrush Dr Austin, Texas 78758
 (512) 452-1515 (800) 428-7412
 Fax (512) 833-7499

www.ctmrs.com
 email: info@ctmrs.com

Seguin – Plant / Sales Office
 720 West IH 10 Seguin, Texas 78155
 (830) 379-3600 (877) 622-8677
 Fax (830) 379-8753

Central Texas Metal Roofing Supply Co., Inc

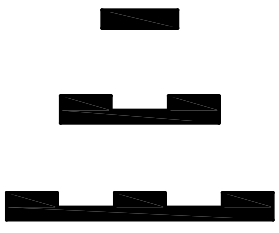
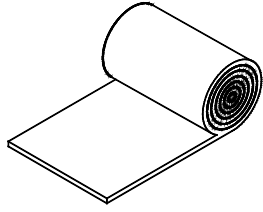
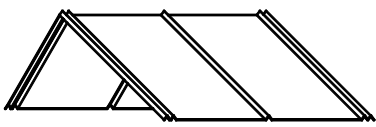
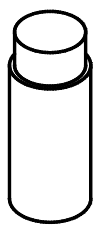
ITEM	DESCRIPTION				PRICE	
	PART NUMBER	SIZE	CARTON QUANTITY	CARTON WEIGHT		
BUTYL TAPE SEALER 	TAPEBUTYL0375	3/8" X 3/32" X 45'	24 ROLLS	45.20		
	TAPEBUTYL0875	7/8" X 3/16" X 25'	14 ROLLS	60.75		
	TAPE250	2 1/2" X 3/16" X 20'	6 ROLLS	23.00		
REFLECTIVE INSULATION  SINGLE BUBBLE FOIL BACKING	PART NUMBER	LENGTH	WIDTH	WEIGHT		
	INSAAS48FOIL	125'-0"	4'-0"	50.00		
DIE FORMED RIDGE CAP  SPECIFY ROOF SLOPE MAX. 6/12	PART NUMBER	LENGTH	GIRTH	WEIGHT		
	DIE5V	36"	24"	8.89		
TOUCHUP PAINT 	PART NUMBER	SIZE	TYPE			
	PNTK2	2 OZ	KYNAR - BRUSH ON (BRUSH NOT INCLUDED)			
	PNTS425	4.25 OZ	SMP - BRUSH ON			
Kynar 500 ® Flashing – 24Ga Typ. Galvalume® and SMP Flashing – 26Ga Typ. Galvalume® = Acrylic Coated Galvalume Galvalume is a trademark of BIEC , Inc.						

Austin – Headquarters / Sales Office
 830 Sagebrush Dr Austin, Texas 78758
 (512) 452-1515 (800) 428-7412
 Fax (512) 833-7499

www.ctmrs.com
 email: info@ctmrs.com

Seguin – Plant / Sales Office
 720 West IH 10 Seguin, Texas 78155
 (830) 379-3600 (877) 622-8677
 Fax (830) 379-8753

Central Texas Metal Roofing Supply Co., Inc

TRIM NOTES

1. All Galvalume® and SMP Painted standard trim is 26 gauge.
2. All Kynar 500® and Metallic Kynar 500® standard trim is 24 gauge.
3. 24 gauge Galvalume® trim is available - please request a quote.
4. All painted trim is fabricated with protective film to prevent scratches.
If you prefer trim without plastic film, please indicate this at the time of order.
Please request a quote for custom trim in length of 20'-02" up to 28'-0". Minimum order required.

DELIVERY

- | | |
|--|--|
| 1. Stock colors (See Color Chart) | Approximately 2 Working Days |
| 2. Non stock colors, gauges and metals | Please Inquire with CTMRS sales staff. |

Galvalume® and Acrylic Coated Galvalume® are unfinished products.
Shade variations, color difference and a rate of weathering in unfinished product such as Galvalume® and Acrylic Coated Galvalume® should be anticipated and are not a cause for rejection.
Use a pre-painted finish if uniform weathering and appearance is crucial.

Austin – Headquarters / Sales Office
830 Sagebrush Dr Austin, Texas 78758
(512) 452-1515 (800) 428-7412
Fax (512) 833-7499

www.ctmrs.com
email: info@ctmrs.com

Seguin – Plant / Sales Office
720 West IH 10 Seguin, Texas 78155
(830) 379-3600 (877) 622-8677
Fax (830) 379-8753